



GRAIN BINS



- Farm
- Commercial
- Hopper Bottom

SIDEWALL SHEETS

Our advanced roll-forming equipment and fixtures ensure close tolerances and high quality for the best fitting bin on the market.

Our sidewall sheets start out as coils of flat **American steel**. Our machines form the corrugations, punch the bolt holes and create the curve in the sheets, all to our tight tolerances. Every major component of a Sukup® Grain Bin starts out as blank steel that our dedicated employees use to create a top-quality finished product that they, and you, can be proud of.

- The precision-engineered, 4" wide corrugated, G90 high-strength, galvanized steel sidewall sheets provide better vertical load carrying capacity
- 4" wide corrugations also create less resistance and friction to allow grain to flow more easily
- We have streamlined bin erection by producing sidewall sheets with bolt holes that align properly, and also by pre-punching sheets for flashing, bolt-on base angle and Fastir® stirring machine track (optional and at no charge)



SUPER SHIELD® COATING

- Provides an extra layer of protection
- Enhances color uniformity
- Clean, dry surface prevents oily coating from attracting dirt and grime
- Keeps your Sukup Grain Bin looking bright and new longer
- Helps prevent white rust
- Sheets need to be stored according to our guidelines prior to erection



You can have your transition openings pre-cut for your Sukup Fans at a nominal charge.

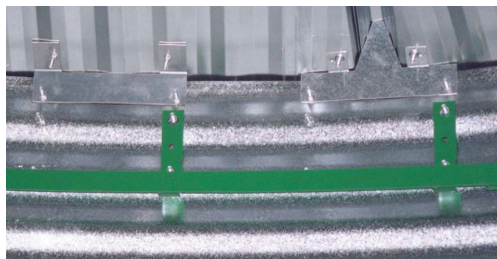

Sukup Bins can be pre-punched for Fastir® track.



TOP QUALITY BOLTS

Sukup's dedication to quality doesn't stop with the "big things". We obsess over the little things, like bolts, too.

- Bolts on Grain Bins are SAE Grade 8.0 (highest standard in the industry) with 1000-hour plating
- Polyethylene washers are used on the bolts that join the sidewall sheets to form a weather-tight bond
- All vertical seams are bolted in the peak and valley



BOLT GRADE	PROOF LOAD (PSI)	YIELD STRENGTH (PSI)	TENSILE STRENGTH (PSI)
 8.0	120,000	130,000	150,000
5	85,000	92,000	120,000
2	55,000	57,000	74,000

ROLLED FLANGE OR BASE ANGLE

Most Farm Bins are available with either a rolled flange bottom sheet or bolt-on base angle.



SERRATED FLANGE NUTS

Sukup uses serrated flange nuts to join and secure the roof panels.

- The flanges make erection quicker and easier
- Serrations grip the roof surface and prevent the nut from working loose
- Flange nuts increase the connection strength and form a tighter seal



ANCHOR BRACKET

As with many other aspects of our bins, Sukup has taken the anchor bracket to a new level.

- The anchor bracket is 22" high to extend above the plenum area, and serves as a short stiffener
- Extending the bracket reduces the stresses caused by vertical loads on the sidewall sheets at the bottom ring
- Patented design allows them to be reversed for use with either bolt-on base angle or rolled flange
- Two-piece, channel-shape, L-bracket transfers vertical load directly to the concrete foundation, preventing damage to the bracket and/or bottom bin sheet
- The exclusive bracket also prevents vertical and horizontal movement of the bottom sidewall sheets

Anchor Brackets
Patent No. 6,941,712



ROOF RUNGS & LADDERS

- All bins are equipped with eave-to-peak roof ladder rungs
- Inside and outside ladders are needed for your safety and are available to your preference
- Handrails are continuous and rungs are securely fastened so they can't turn and sealed, eliminating the need for plugs
- Rungs have a rounded design, eliminating sharp edges
- Steps around the perimeter of the fill hole are standard and increase safety and convenience when working around the top of the bin
- Cages are available for outside ladders for increased safety
- Manhole access platforms, landing platforms and stairs are also available
- All bins are equipped with 2,000 lb. restraint anchor



OSHA
Compliant
Fall Arrest
System



BIN STEP

The bin step (included standard) is made from heavy-gauge galvanized steel with a special non-slip surface that does not hold water, providing sure footing no matter what the weather.

The bin step is notched to fit around Sukup anchor brackets, ensuring proper placement and a good fit.



BIN STAIRS



BIN DOORS

- Sukup offers two bin door designs - a 66" door and a 44" door for taller bins
- Both doors are made of heavy-gauge, galvanized steel and are factory-assembled for a good fit and seal
- Outer Bin doors feature a reversible hinge that allows the door to open to the left or right, whichever works best for your system
- The top and bottom latches on the outer door are connected for one-hand operation

INNER DOOR

- Sukup has designed a truly convenient inner bin door
- There are no tie-bars to contend with
- Door hinges are specially designed to swing open to rest flat against the sidewall
- The door latch allows single-handed operation and provides plenty of room for hands and knuckles during operation
- The Hammer Head™ latches ensure easy opening of the doors

SAFETY LATCH

- Assures the inner panels are closed and secured when properly engaged
- Can help prevent injury or death caused by neglecting to close and secure inner door panels
- Patented catch is mounted to the inner door panel handles providing the catches for the outer door latches
- Available for all 44" and 66" doors and can be mounted on left or right side

Grain Bin Safety Door
Patent No. 11,111,074



*Inner Panels Closed & Secured,
Door Skin Open*



Door Skin Shut, Not Latched



Door Skin Shut, Latched

**WANT TO SEE THE
DOOR IN ACTION?
SCAN THE QR
TO LEARN MORE
ABOUT OUR GRAIN
BIN SAFETY DOOR!**



BIN ROOFS

Roof rings are standard on bins 18' and larger. Exclusive, patented roof ring clips ensure that roof rings stay in place for years to come.



Roof Ring Clips
Patent No. 7,654,048

The lower ribs on roofs are slightly smaller than the upper to allow the sheets to nest properly and create a tighter seal than other roofs. Our extra-tall 3" ribs serve as rafters, strengthening our roof sheets. The hemmed edge eliminates sharp edges and increases strength of roof sheet.



ROOF TO SIDEWALL CONNECTION

Sukup has the strongest roof-to-sidewall connections in the industry.

- With standard double-tab roof clips, sheets are supported every $9\frac{3}{8}$ " at the eave
- Optional continuous eave clips are available for even greater strength
- Heavier galvanization on roof



EXTRA-STRONG FARM ROOF: 5,000 LB.

Sukup has designed our 15' - 48' diameter bins with a rating of 5,000 lbs., evenly distributed on peak ring as pure vertical peak load with uniformly distributed roof snow load calculated from 40 psf ground snow zone or 105 mph wind zone by ASCE7-10 (for comparison, this is equivalent to a 12,000 lb. vertical load if based on 30 psf ground snow zone with a 36' bin). An optional 8,000 lb. roof is available on 42' and 48' bins.

The strength of our roofs starts with high-strength steel. Each roof sheet is then rigidized every 4" to increase the stiffness of the galvanized steel panels, making them easier to handle.

- G115 galvanized steel is used for all roof sheets
- 3" ribs serve as rafters for the roof structure, thereby strengthening the sheets
- The bends on each side of the ribs further increase strength, allowing roofs to withstand heavy snow loads and high winds
- The upper (overlapping) ribs are slightly larger than the lower, allowing the sheets to completely overlap and nest properly; We take the extra step of using two different size rollers to make the ribs on our roof sheets



EXTRA-LARGE, EXTRA-STRONG FILL HOLE

- The fill hole is an extra-large 38", providing approximately 8ft² of air exhaust area
- The domed fill hole cap is mounted on steel rods to allow it to slide open and closed and prevent it from being thrown around on windy days



- Optional 60" octagonal diamond deck lid may be used in place of the domed lid

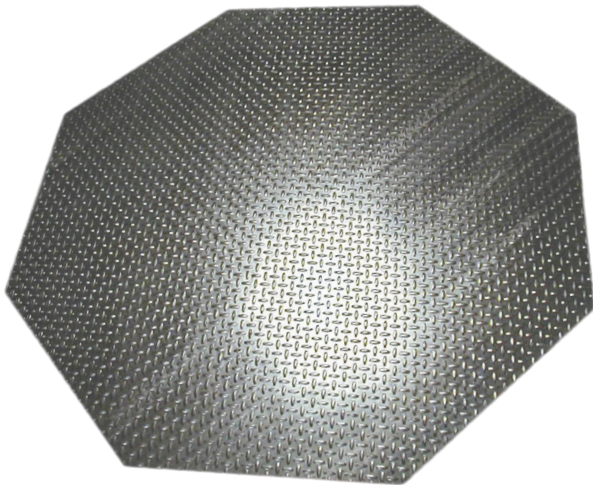

- Optional remote lid opener allows the fill hole cap to be opened from the ground

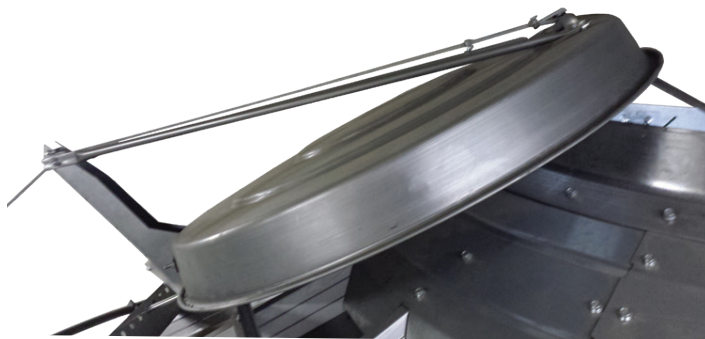

MANHOLE

Sukup designed our bin roofs with a larger manhole - an oval opening that measures 20" x 35.5" - making it a comfortable fit for most operators.

- Allows over 4 ft² of air exhaust area
- A formed lip and rubber gasket keep rain and snow out of the bin
- The cover fits securely over the lip, preventing any moisture leakage
- Special latches hold the manhole cover firmly in place; The latches can be easily released from the ladder side
- When open, the door lays flat against the roof, eliminating the mess of water and soggy fines

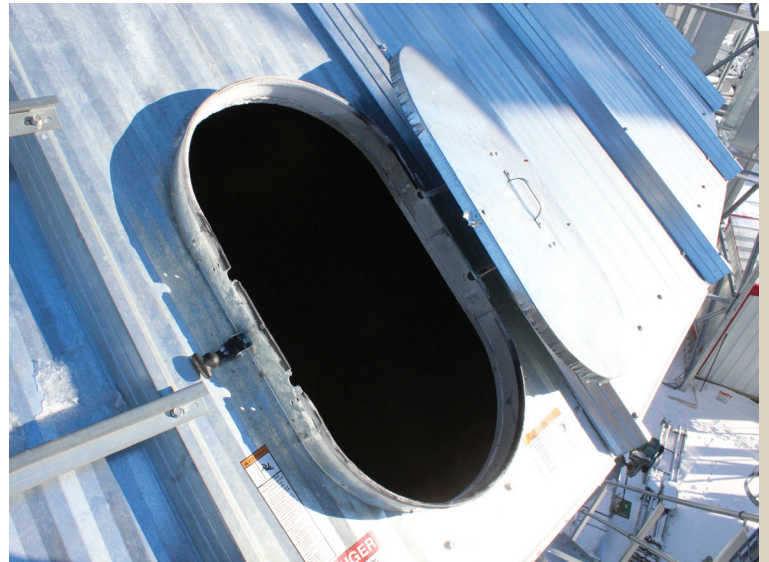

Fines and water won't collect in lid!



ROOF VENTS

True to our mission to provide the greatest value for your money, Sukup has developed a roof vent that not only does the job of releasing moisture from the bin, but it also protects the bin roof.

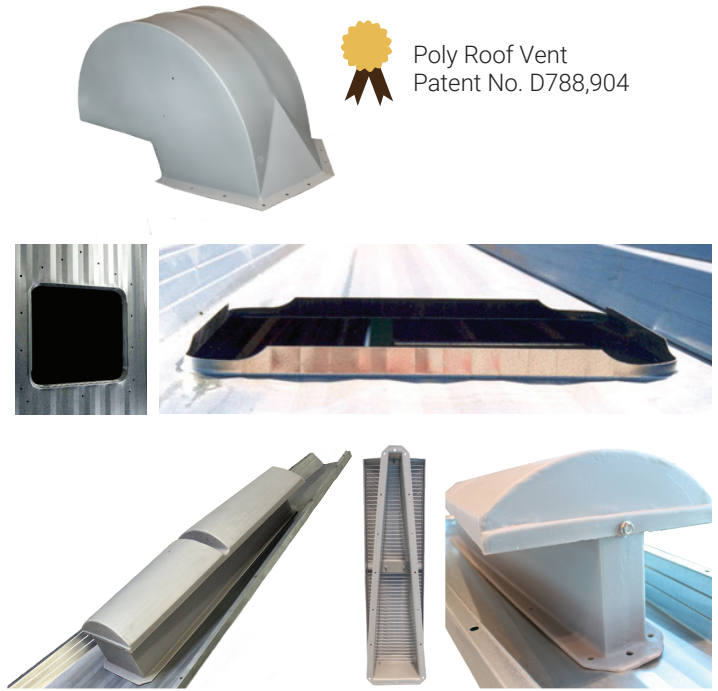

- Patented 18" poly vents are virtually indestructible
- Built-in debris deflectors prevent dirt and fines from accumulating on the upper side of the vent and causing corrosion of the roof sheet
- Poly vents are covered by a 5-year limited warranty
- 2.25 square foot opening
- Roof sheets can be pre-punched for 18" roof vents
- Pre-punching produces an extra-tall (1 1/8") lip that works as a barrier, preventing moisture from leaking into the bin through the opening
- Tapered poly vent mounts near the peak of the bin allowing moisture from that area to escape during the drying process
- Reduces the amount of moisture deposited on the upper portion of the grain during cooling
- Used in conjunction with standard 18" vents
- 1.5 square foot opening



Poly Roof Vent
Patent No. D788,904



DANGERS OF ENTERING A GRAIN BIN

-  From the time the auger starts, you have **2 seconds** to react
-  In **4 seconds** you are trapped
-  After **8 seconds**, you are completely covered

IF YOU MUST ENTER THE BIN

- **STATION** an observer outside the bin door who can be in constant contact and available with resources to help.
- Lock out **ALL** power when maintaining equipment or entering a bin.
- Use approved **PERSONAL PROTECTIVE EQUIPMENT (PPE)** including air monitoring equipment to ensure air is safe to breathe.
- Use **PROPER** fall arrest systems.
- **BE AWARE** of potential voids or cavities in the grain, damaged grain or crusted grain.

Failure to heed these warnings may result in serious injury or death

STIFFENED FARM BINS

Sukup offers a full line of bins to meet the needs of virtually any grain operation. The chart below may be used as a selection tool. Of course, your local Sukup dealer is your best resource for developing the ideal system to meet your needs.

APPLICATION									
TYPE	BIN	Storage/Aeration	Drying	Stirring Machine	Cooling	Short-term Wet Holding	General Wet Holding	Working	Side Draw
FARM	B	✓	LTD	LTD	✓	✓	⊘	⊘	⊘
	BD	✓	✓	✓	✓	✓	✓	✓	⊘
	BS	✓	LTD	LTD	✓	✓	⊘	⊘	⊘
	BSD	✓	✓	✓	✓	✓	✓	✓	⊘
HOPPER	BHM	✓	⊘	⊘	⊘	✓	⊘	LTD	⊘
	BH	✓	⊘	⊘	⊘	✓	SQ	LTD	SQ
COMMERCIAL	BC	✓	⊘	⊘	⊘	LTD	SQ	SQ	✓*

✓	Designed for this application
⊘	NOT designed for this application
LTD	Limited by size of bin
SQ	Special Quote, contact Sukup
*	Available on bins up to 105' diameter

STIFFENERS

Adding stiffeners to a bin allows the use of lighter gauge sidewall sheets without sacrificing structural strength; thereby, making a stiffened bin more economical.

- Provides excellent structural stability against grain, wind and seismic loads
- Transfer roof loads directly to the foundation resulting in less stress on the sidewall sheets
- Stiffened Bins are the strongest available
- Available with bolt-on base angle only
- Patented anchor system makes installation easier
- Base stiffeners cover the bottom two wall sheets and extend into the third ring from the bottom for better support
- Farm stiffeners have up to a 42,000 lb. effective load capacity



 Anchor System Patent No. 8,516,769

- Extra-strong stiffeners are made from high-strength steel formed into a specifically-engineered shape to maximize the strength of the steel; The end result is a stiffener that will stand straight and strong for many years - and bushels - to come
- The top stiffener is tapered to fit under the bin roof and bolts to the top horizontal bolt hole making a stronger connection
- Splices are 14" tall and fit inside stiffener profile; This ensures proper alignment of stiffeners to carry vertical load



DRYING BINS

For over 55 years Sukup has been making grain drying more efficient and profitable. We have the equipment to do the job, and do it right, including bins designed for the stresses of in-bin drying.

Our standard stiffened and non-stiffened bins are designed for stir drying with three or fewer down auger stirring machines. If you're using a continuous flow drying system with a horizontal bottom unload, a top dry system, a recirculator system with a center, vertical unload or a stirring machine with four or more down augers, a Heavy Gauge Drying Bin is the bin you need. Heavy Gauge Drying Bins were specifically-designed for the demands of these in-bin continuous flow drying systems.

The 32° pitch on Sukup Bin Roofs allows moisture to drain off easily.

HEAVY GAUGE DRYING BINS	NO. OF RINGS	EAVE HEIGHT	DIAMETER	STIFFENED	NON-STIFFENED	STIRRING
	5	18' 5"	15' - 48'	✓	✓	✓
	6	22' 1"	15' -48'	✓	✓	✓
	7	25' 9"	15' - 48'	✓		

FANS AND HEATERS

- Fans and heaters available in either axial or centrifugal



UNLOADING EQUIPMENT

- The patent pending Paddle Sweepway is a safe option to fully clean out a grain bin



 Patent Pending

STIRRING MACHINE

- The Fastir® simply the most dependable stirring machine available
- Patented mechanical reversing system makes the Fastir trouble-free

 Mechanical Reversing Drive
Patent No. 5,570,954



DRYING BIN SPECIFICATIONS

DIA.	NO. OF RINGS	MAX CAP.	LEVEL CAP.	MAX CAP. W/ PLENUM	LEVEL CAP. W/ PLENUM	EAVE HT.	PEAK HT.
15'	3	1,848	1,651	1,693	1,496	11' 1"	15' 6"
	4	2,395	2,198	2,239	2,042	14' 9"	19' 2"
	5	2,941	2,744	2,786	2,589	18' 5"	22' 10"
	6	3,487	3,290	3,332	3,135	22' 1"	26' 6"
	7	4,033	3,836	3,878	3,681	25' 9"	30' 2"
	8	4,580	4,383	4,425	4,228	29' 5"	33' 10"
	9	5,126	4,929	4,971	4,774	33' 1"	37' 6"
	10	5,672	5,475	5,517	5,320	36' 9"	41' 2"
	11	6,219	6,022	6,063	5,866	40' 5"	44' 10"
	12	6,765	6,568	6,610	6,413	44' 1"	48' 6"
18'	3	2,718	2,378	2,495	2,154	11' 1"	16' 5"
	4	3,505	3,165	3,281	2,941	14' 9"	20' 1"
	5	4,292	3,951	4,068	3,728	18' 5"	23' 9"
	6	5,078	4,738	4,855	4,514	22' 1"	27' 5"
	7	5,865	5,525	5,641	5,301	25' 9"	31' 1"
	8	6,652	6,311	6,428	6,088	29' 5"	34' 9"
	9	7,438	7,098	7,215	6,874	33' 1"	38' 5"
	10	8,225	7,885	8,001	7,661	36' 9"	42' 1"
	11	9,012	8,671	8,788	8,448	40' 5"	45' 9"
	12	9,798	9,458	9,575	9,234	44' 11"	49' 5"
21'	3	3,777	3,237	3,473	2,932	11' 1"	17' 4"
	4	4,848	4,307	4,544	4,003	14' 9"	21'
	5	5,919	5,378	5,614	5,074	18' 5"	24' 8"
	6	6,989	6,449	6,685	6,145	22' 1"	28' 4"
	7	8,060	7,520	7,756	7,215	25' 9"	32'
	8	9,131	8,590	8,827	8,286	29' 5"	35' 8"
	9	10,202	9,661	9,897	9,357	33' 1"	39' 4"
	10	11,272	10,732	10,968	10,428	36' 9"	43'
	11	12,343	11,802	12,039	11,498	40' 5"	46' 8"
	12	13,414	12,873	13,110	12,569	44' 1"	50' 4"
24'	3	5,034	4,227	4,637	3,830	11' 1"	18' 3"
	4	6,433	5,626	6,035	5,229	14' 9"	21' 11"
	5	7,831	7,024	7,434	6,627	18' 5"	25' 7"
	6	9,230	8,423	8,833	8,026	22' 1"	29' 3"
	7	10,628	9,821	10,231	9,424	25' 9"	32' 11"
	8	12,027	11,220	11,630	10,823	29' 5"	36' 7"
	9	13,425	12,618	13,028	12,221	33' 1"	40' 3"
	10	14,824	14,017	14,427	13,620	36' 9"	43' 11"
	11	16,222	15,416	15,825	15,018	40' 5"	47' 7"
	12	17,621	16,814	17,224	16,417	44' 1"	51' 3"
27'	3	6,499	5,350	5,996	4,847	11' 1"	19' 3"
	4	8,269	7,120	7,766	6,617	14' 9"	22' 11"
	5	10,039	8,890	9,536	8,387	18' 5"	26' 7"
	6	11,809	10,660	11,306	10,157	22' 1"	30' 3"
	7	13,579	12,430	13,076	11,927	25' 9"	33' 11"
	8	15,349	14,200	14,846	13,697	29' 5"	37' 7"
	9	17,119	15,970	16,616	15,467	33' 1"	41' 3"
	10	18,889	17,740	18,386	17,237	36' 9"	44' 11"
	11	20,659	19,510	20,156	19,007	40' 5"	48' 7"
	12	22,429	21,280	21,926	20,777	44' 1"	52' 3"
30'	3	8,181	6,605	7,560	5,984	11' 1"	20' 2"
	4	10,366	8,790	9,746	8,170	14' 9"	23' 10"
	5	12,552	10,976	11,931	10,355	18' 5"	27' 6"
	6	14,737	13,161	14,116	12,540	22' 1"	31' 2"
	7	16,922	15,346	16,301	14,725	25' 9"	34' 10"
	8	19,107	17,531	18,486	16,910	29' 5"	38' 6"
	9	21,292	19,716	20,672	19,096	33' 1"	42' 2"
	10	23,478	21,902	22,857	21,281	36' 9"	45' 10"
	11	25,663	24,087	25,042	23,466	40' 5"	49' 6"
	12	27,848	26,272	27,227	25,651	44' 1"	53' 2"

DIA.	NO. OF RINGS	MAX CAP.	LEVEL CAP.	MAX CAP. W/ PLENUM	LEVEL CAP. W/ PLENUM	EAVE HT.	PEAK HT.	
33'	3	10,090	7,992	9,339	724	11' 1"	21' 1"	
	4	12,734	10,636	11,983	9885	14' 9"	24' 9"	
	5	15,378	13,280	14,627	12,529	18' 5"	28' 5"	
	6	18,022	15,925	17,270	15,173	22' 1"	32' 1"	
	7	20,666	18,569	19,914	17,817	25' 9"	35' 9"	
	8	23,310	21,213	22,559	20,462	29' 5"	39' 5"	
	9	25,954	23,857	25,203	23,106	33' 1"	43' 1"	
	10	28,598	26,501	27,847	25,750	36' 9"	46' 9"	
	11	31,243	29,145	30,491	28,394	40' 5"	50' 5"	
	12	33,887	31,789	33,135	31,038	44' 1"	54' 1"	
	36'	3	12,235	9,512	11,341	8,618	11' 1"	22'
		4	15,381	12,658	14,488	11,764	14' 9"	25' 8"
5		18,528	15,805	17,634	14,911	18' 5"	29' 4"	
6		21,675	18,952	20,781	18,058	22' 1"	33'	
7		24,822	22,098	23,928	21,204	25' 9"	36' 8"	
8		27,968	25,245	27,074	24,351	29' 5"	40' 4"	
9		31,115	28,392	30,221	27,498	33' 1"	44'	
10		34,262	31,538	33,368	30,644	36' 9"	47' 8"	
11		37,408	34,685	36,514	33,791	40' 5"	51' 4"	
12		40,555	37,832	39,661	36,938	44' 1"	55'	
42'		3	17,271	12,946	16,054	11,729	11' 1"	23' 11"
		4	21,554	17,229	20,337	16,012	14' 9"	27' 7"
	5	25,837	21,512	24,620	20,295	18' 5"	31' 3"	
	6	30,120	25,795	28,903	24,578	22' 1"	34' 11"	
	7	34,403	30,078	33,186	28,861	25' 9"	38' 7"	
	8	38,686	34,361	37,469	33,144	29' 5"	42' 3"	
	9	42,969	38,644	41,752	37,427	33' 1"	45' 11"	
	10	47,252	42,927	46,035	41,710	36' 9"	49' 7"	
	11	51,534	47,210	50,318	45,993	40' 5"	53' 3"	
	12	55,817	51,493	54,601	50,276	44' 1"	56' 11"	
	48'	3	23,365	16,909	21,775	15,320	11' 1"	25' 9"
		4	28,959	22,503	27,369	20,914	14' 9"	29' 5"
5		34,553	28,098	32,964	26,508	18' 5"	33' 1"	
6		40,147	33,692	38,558	32,102	22' 1"	36' 9"	
7		45,741	39,286	44,152	37,696	25' 9"	40' 5"	
8		51,335	44,880	49,746	43,291	29' 5"	44' 1"	
9		56,929	50,474	55,340	48,885	33' 1"	47' 9"	
10		62,523	56,068	60,934	54,479	36' 9"	51' 5"	
11		68,117	61,662	66,528	60,073	40' 5"	55' 1"	
12		73,711	67,256	72,122	65,667	44' 1"	58' 9"	

Sukup Manufacturing Co. provides this information to assist you in choosing the optimal equipment for your situation. Sukup specifications should be used only as estimates, and not as a warranty, express or implied, of how a particular Sukup unit will perform under your varying operating conditions. Because we are continuously improving Sukup products, changes may occur that may not be reflected in the specifications.

Max. capacities (cap.) are shown in bushels and based on ASABE Standard S413.1 - bins with no plenum and grain peaked at 28° angle of repose with 6% compaction.

Plenum height calculated at 12.5".

Figures shown in black apply to all Sukup Farm Bins.

Figures shown in green apply only to Sukup Stiffened Farm Bins.

MEDIUM DUTY (MD) HOPPER BINS

- Standard: 15' -21', 3-6 rings, 45° hopper
- Available: 12', 3- 5 rings, 60° hopper; 15', 3 -6 rings, 60° hopper
- May be mounted on overhead super structure
- Ideal for use as a wet holding tank to feed your Sukup Grain Dryer
- May be used to store cool, dry grain for an extended period of time
- Legs are formed in our extra-strong stiffener profile; The legs extend to the bottom two rings, providing additional support for the sidewalls
- 12', 15' and 18' diameter bins have three legs per sidewall sheet; 21' diameter bins have four legs per sheet
- Angle-shaped leg cross bracing and C-shaped leg-to-hopper bracing provide solid support; Cross bracing is located high on the legs to allow easy access to the hopper outlet
- Panels for the hopper portion attach directly to the sidewall sheets, so there is no ledge to trap grain; Panels bolt together

HOPPER BOTTOM BINS

MD and HD Hopper Bottom Bins are among the strongest in the industry, with wide corrugations, extra-strong stiffeners and heavy-gauge hopper panels.

- Wheel extension standard
- Tank portion features the same quality sidewall construction as standard Sukup Bins, as well as the same extra-strong roof; 44" door is optional on heavy-duty hopper bins
- Sukup hoppers are made of heavy-gauge, galvanized steel for strength and durability
- Round-head bolts throughout the hopper portion prevent grain from getting hung-up and bridging
- Standard hoppers are 45°
- Contact Sukup for 60° hopper options
- Hopper Bottom Bins are designed to hold free-flowing grains up to 52 lbs/ft³, with an unload rate of 19,000 BPH.
- Rack and pinion roller slide gate, standard on the large, 16" diameter unloading outlet, makes it easier to open and close; Optional chain wheel available for Heavy-Duty Hopper Bins mounted on overhead structures
- Ample ground clearance to allow for an auger take-up
- Optional 22" unload outlet is available with an unload rate of 40,000 BPH; If used with grain heavier than 40 lbs/ft³ may require roof vents and heavier sidewalls (Rates based on clean, dry, free-flowing grain)

MD HOPPER BINS SPECIFICATIONS								
DIA.	HOPPER	NO. OF RINGS	TOTAL CAPACITY BUSHELS	TONS	EAVE HT.	PEAK HT.	HOPPER HT.	GROUND CLEARANCE*
12'	60°	3	1492	40	23' 5"	26' 2"	12' 9"	3'
		4	1841	51	27' 1"	29' 10"	12' 9"	3'
		5	2191	61	30' 9"	33' 6"	12' 9"	3'
15'	60°	3	2500	74	26' 0"	30' 5"	15' 4"	3'
		4	3047	90	29' 8"	34' 1"	15' 4"	3'
		5	3593	107	33' 4"	37' 9"	15' 4"	3'
15'	45°	3	2224	70	21' 1"	25' 6"	10' 5"	3'
		4	2771	88	24' 9"	29' 2"	10' 5"	3'
		5	3317	105	28' 5"	32' 10"	10' 5"	3'
18'	45°	3	3368	107	22' 3"	27' 7"	11' 7"	3'
		4	4155	131	25' 11"	31' 3"	11' 7"	3'
		5	4942	156	29' 7"	34' 11"	11' 7"	3'
21'	45°	3	5728	181	33' 3"	38' 7"	11' 7"	3'
		4	4810	152	24' 0"	30' 3"	13' 4"	3'
		5	5881	186	27' 8"	33' 11"	13' 4"	3'
21'	45°	6	6952	220	31' 4"	37' 7"	13' 4"	3'
		6	8022	254	35' 0"	41' 3"	13' 4"	3'

Bin capacities and weights are calculated on ASABE S.413.1 Standard with 6% grain compaction.

* Ground clearance for hopper bins with rack & pinion. For clearance without rack & pinion, add 5" to ground clearance shown.



HEAVY DUTY (HD) HOPPER BINS

- May be mounted on overhead super structures for loading of semis or train cars
- May be used as a working bin - a working bin is defined as refilling 25% or more of the maximum bin capacity more than 12 times a year, where new grain settles for more than 72 hours per occurrence; Working bins require grain to be unloaded by gravity out of the center sump only
- Can be used to store cool, dry grain for an extended period of time



HOPPER BASE

The base for your Heavy-Duty Hopper Bottom Bin is tailored to the size of the bin and the load capacity required. All base configurations start with 70,000 psi tensile strength steel, wide flange legs. The wide flange (I-beam) construction makes the legs extra-strong and stable, and L-shaped cross-bracing between the legs adds even more stability.

INNER APRON

Heavy Duty Hopper Bottom Bins feature hopper ring flashing that covers the ledge where the tank and bottom cone join. This flashing prevents grain from accumulating on the ledge and allows grain to flow freely into the hopper.

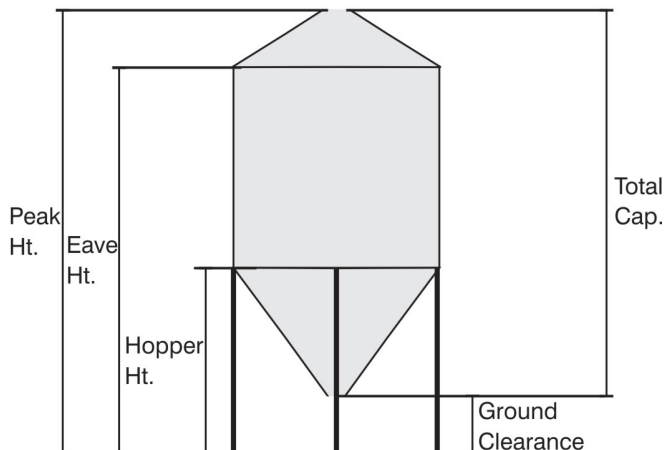
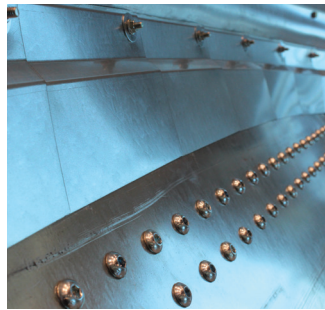

Bin capacities and weights are calculated on ASABE S.413.1 Standard with 6% grain compaction.

* Ground clearance for hopper bins with rack & pinion. For clearance without rack & pinion, add 5" to ground clearance shown.

Up to 48' Diameter & 24 rings available: Call Sukup

HD HOPPER BINS SPECIFICATIONS								
DIA.	NO. OF RINGS	TOTAL CAPACITY BUSHELLS	TONS	EAVE HT.	PEAK HT.	HOPPER HT.	GROUND CLEARANCE*	
15'	3	2,224	70	21' 2"	25' 7"	10' 1"	3'	
	4	2,771	88	24' 10"	29' 3"	10' 1"	3'	
	5	3,317	105	28' 6"	32' 11"	10' 1"	3'	
	6	3,863	122	32' 2"	36' 7"	10' 1"	3'	
	7	4,409	140	35' 10"	40' 3"	10' 1"	3'	
	8	4,956	157	39' 6"	43' 11"	10' 1"	3'	
	9	5,502	174	43' 2"	47' 7"	10' 1"	3'	
	10	6,048	191	46' 10"	51' 3"	10' 1"	3'	
	11	6,595	209	50' 6"	54' 11"	10' 1"	3'	
	12	7,141	226	54' 2"	58' 7"	10' 1"	3'	
	18'	3	3,368	107	22' 8"	28' 0"	11' 7"	3'
		4	4,155	131	26' 4"	31' 8"	11' 7"	3'
5		4,942	156	30' 0"	35' 4"	11' 7"	3'	
6		5,728	181	33' 8"	39' 0"	11' 7"	3'	
7		6,515	206	37' 4"	42' 8"	11' 7"	3'	
8		7,302	231	41' 1"	46' 5"	11' 8"	3'	
9		8,088	256	44' 9"	50' 1"	11' 8"	3'	
10		8,875	281	48' 5"	53' 9"	11' 8"	3'	
11		9,662	306	52' 1"	57' 5"	11' 8"	3'	
12		10,448	331	55' 9"	61' 1"	11' 8"	3'	
21'		3	4,810	152	24' 2"	30' 5"	13' 1"	3'
		4	5,881	186	27' 10"	34' 1"	13' 1"	3'
	5	6,952	220	31' 6"	37' 9"	13' 1"	3'	
	6	8,022	254	35' 2"	41' 5"	13' 1"	3'	
	7	9,093	288	38' 10"	45' 1"	13' 1"	3'	
	8	10,164	322	42' 7"	48' 10"	13' 2"	3'	
	9	11,235	356	46' 3"	52' 6"	13' 2"	3'	
	10	12,305	389	49' 11"	56' 2"	13' 2"	3'	
	11	13,376	423	53' 7"	59' 10"	13' 2"	3'	
	12	14,447	457	57' 3"	63' 6"	13' 2"	3'	
	24'	3	6,576	208	25' 8"	32' 10"	14' 7"	3'
		4	7,975	252	29' 4"	36' 6"	14' 7"	3'
5		9,373	297	33' 0"	40' 2"	14' 7"	3'	
6		10,772	341	36' 8"	43' 10"	14' 7"	3'	
7		12,170	385	40' 4"	47' 6"	14' 7"	3'	
8		13,569	429	44' 1"	51' 3"	14' 8"	3'	
9		14,967	474	47' 9"	54' 11"	14' 8"	3'	
10		16,366	518	51' 5"	58' 7"	14' 8"	3'	
11		17,764	562	55' 1"	62' 3"	14' 8"	3'	
12		19,163	606	58' 9"	65' 11"	14' 8"	3'	
27'		3	8,694	275	27' 2"	35' 4"	16' 1"	3'
		4	10,464	331	30' 10"	39' 0"	16' 1"	3'
	5	12,234	387	34' 6"	42' 8"	16' 1"	3'	
	6	14,004	443	38' 2"	46' 4"	16' 1"	3'	
	7	15,774	499	41' 10"	50' 0"	16' 1"	3'	
	8	17,544	555	45' 7"	53' 9"	16' 2"	3'	
	9	19,314	611	49' 3"	57' 5"	16' 2"	3'	
	10	21,084	667	52' 11"	61' 1"	16' 2"	3'	
	11	22,854	723	56' 7"	64' 9"	16' 2"	3'	
	12	24,624	779	60' 3"	68' 5"	16' 2"	3'	
	30'	3	11,192	354	28' 9"	37' 10"	17' 8"	3'
		4	13,377	423	32' 5"	41' 6"	17' 8"	3'
5		15,563	493	36' 1"	45' 2"	17' 8"	3'	
6		17,748	562	39' 9"	48' 10"	17' 8"	3'	
7		19,933	631	43' 5"	52' 6"	17' 8"	3'	
8		22,118	700	47' 1"	56' 2"	17' 8"	3'	
9		24,303	769	50' 9"	59' 10"	17' 8"	3'	
10		26,489	838	54' 5"	63' 6"	17' 8"	3'	
11		28,674	907	58' 1"	67' 2"	17' 8"	3'	
12		30,859	977	61' 9"	70' 10"	17' 8"	3'	
36'		8	33,171	990	51' 1"	62'	21' 8"	4'
		9	36,318	1,084	54' 9"	65' 8"	21' 8"	4'
	10	39,465	1,178	58' 5"	69' 4"	21' 8"	4'	
	11	42,611	1,272	62' 1"	73'	21' 8"	4'	
	12	45,758	1,366	65' 9"	76' 8"	21' 8"	4'	
	13	48,905	1,460	69' 5"	80' 4"	21' 8"	4'	
	14	52,052	1,554	73' 1"	84'	21' 8"	4'	
	15	55,199	1,648	76' 9"	87' 8"	21' 8"	4'	
	16	58,346	1,742	80' 5"	91' 4"	21' 8"	4'	
	17	61,493	1,836	84' 1"	95'	21' 8"	4'	
	18	64,640	1,930	87' 9"	98' 8"	21' 8"	4'	

COMMERCIAL BINS

DOUBLE-ENDED STUD BOLTS

Double ended stud bolts eliminate water infiltration between laminated sheets and grain at stiffener location.



 Double-Ended Stud Bolt
Patent No. 10,407,935

LAMINATED SPLICE PLATE

On larger commercial bins, patented laminated splice plates reduce the risk of bolt shear. Instead of overlapping the edges of laminated sidewall sheets, we use a butt joint and specially designed splice plates. The design makes the bin easier to erect because the holes are properly aligned, and eliminates gaps that can lead to leaking.

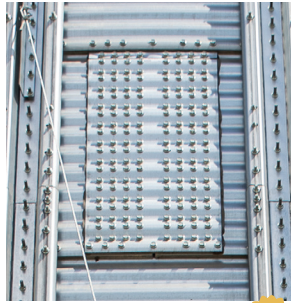

 Laminated Splice Plate
Patent No. 8,291,664

SAFETY FEATURES

Knot-Passing Pulley, restraint anchor and feeder line come standard on all Sukup bins with structured roofs. (Certified Safety Line not included.)



BOLT PATTERNS

- The bolt patterns and sizes on commercial bins vary by bin diameter and are engineered to maximize the strength of the connection and form the strongest bond
- Commercial Bin bolts are 1000-hour plating or equivalent coating, SAE Grade 8.0

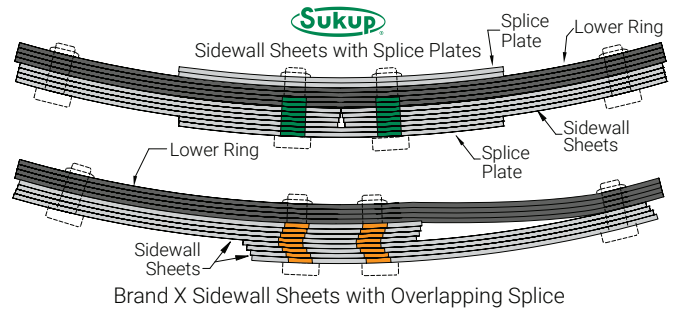
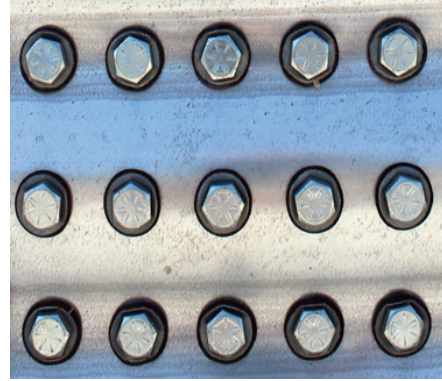

PEAK DECK SIZES

50,000, 100,000, & 150,000 LB.

- 10' across on 36'-48' bin
- 12' across on 54'-60' bin
- 16' across on 72'-135' bin
- 21' across on 156'-165' bin



90'-135': 16' Flat Deck
156'-165': 21' Flat Deck

Flat top peak decks standard on 50K, 100K, or 150K roof, 36' and larger.

Image shown with optional conveyor support

ROOFS

Sukup offers commercial roofs with 15,000, 30,000, 50,000, 100,000, or 150,000 lb. peak load ratings. Roof ratings are based on weight evenly distributed on peak ring as pure vertical peak load with 105 mph wind zone or uniformly distributed roof snow load calculated from 40 psf ground snow zone as defined by ASCE7-10 Code.

30,000 LB., 50,000 LB.*: 36' - 78'

The strength of the 30,000 lb. and 50,000 lb. roof comes from **double C-shaped channels** forming I-beam rafters with C-shaped purlins. Rafters and purlins are manufactured from 70,000 PSI tensile strength galvanized steel.

100,000 LB.*: 72' - 135' &

150,000 LB.*: 156'-165'

Our 100,000 lb. and 150,000 lb. roofs are constructed of **I-beam** rafters and an extra-heavy peak ring all manufactured at Sukup using the latest technology. The rafters in the 156' bin are constructed with 65,000 PSI tensile strength I-beams.

ROOF RINGS

- Roof rings are standard on all commercial roofs for added safety during construction and maintenance
- The number of rings varies depending upon bin diameter

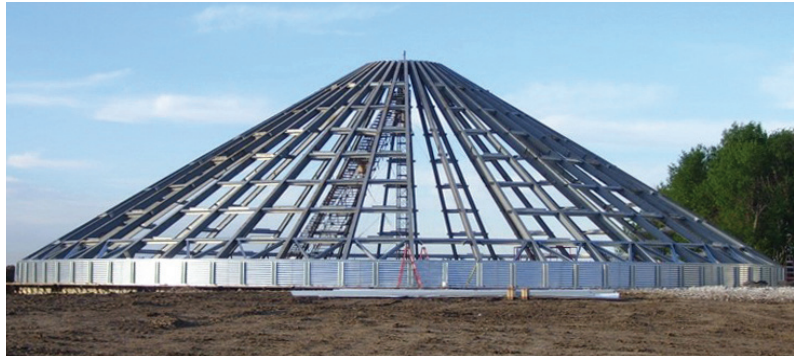

*Standard roof peak loads meet ASCE 7-10 for unbalanced snow load with 40 psf ground snow load.



COMMERCIAL BIN SIZES

DIAMETER	MAX PEAK HEIGHTS	MAX CAPACITIES	MAX RINGS	STANDARD ROOF PEAK LOAD (LBS.)	OPTIONAL ROOF PEAK LOAD (LBS.)
36'	120' 7"	97,200	30	15,000 (5' Peak Lid)	30,000* (5' Peak Lid) or 50,000 (10' Peak Deck)
42'	122' 6"	132,900	30	30,000 (5' Peak Lid)	15,000* (5' Peak Lid) or 50,000 (10' Peak Deck)
48'	124' 6"	174,400	30	30,000 (5' Peak Lid)	15,000* (5' Peak Lid) or 50,000 (10' Peak Deck)
54'	126' 2"	221,700	30	30,000 (5' Peak Lid)	15,000* (5' Peak Lid) or 50,000 (12' Peak Deck)
60'	128' 1"	275,000	30	30,000 (5' Peak Lid)	15,000* (5' Peak Lid) or 50,000 (12' Peak Deck)
72'	132' 1"	399,500	30	50,000 (16' Peak Deck)	30,000* (5' Peak Lid) or 100,000 (16' Peak Deck)
				100,000 (16' Peak Deck)	30,000* (5' Peak Lid) or 100,000 (16' Peak Deck)
75'	133' 0"	434,500	24 30	50,000 (16' Peak Deck)	30,000* (5' Peak Lid) or 100,000 (16' Peak Deck)
				100,000 (16' Peak Deck)	30,000* (5' Peak Lid)
78'	133' 11"	471,000	20 30	50,000 (16' Peak Deck)	30,000* (5' Peak Lid) or 100,000 (16' Peak Deck)
				100,000 (16' Peak Deck)	30,000* (5' Peak Lid)
90'	137' 8"	632,800	30	100,000 (16' Peak Deck)	30,000* (5' Peak Lid)
105'	138' 9"	871,000	30	100,000 (16' Peak Deck)	
135'	147' 11"	1,471,600	30	100,000 (16' Peak Deck)	
156'	125' 7"	1,994,840	30	150,000 (21' Peak Deck)	
165'	155' 7"	2,249,950	30	150,000 (21' Peak Deck)	

All roofs rated for 105 mph wind zone as defined by ASCE 7-10 code

50K, 100K, & 150K roof peak loads meet ASCE 7-10 for unbalanced snow load with 40 psf ground snow load and temperature cables at maximum Sukup quantity.

* Only available up to 24 rings tall

DRYING, STORAGE and HANDLING SOLUTIONS®



We've spent more than 55 years developing innovative, efficient, and reliable products to meet the ever-expanding needs of grain producers. With a full-line of product Solutions®, Sukup has all your grain handling, storage, drying, and steel building needs.



Sukup Manufacturing Co. ■ www.sukup.com

Box 677 ■ 1555 255th Street ■ Sheffield, Iowa 50475-0677 ■ ph 641.892.4222 ■ fx 641.892.4629 ■ info@sukup.com

Distribution Centers

Cameron, MO 64429 7426 NE 352 nd St. ph 816.649.2226 missouri@sukup.com	Arcola, IL 61910 980 E. State Rte. 133 ph 217.268.3026 illinois@sukup.com	Aurora, NE 68818 1705 Hwy. 34 E. ph 402.694.5922 nebraska@sukup.com	Defiance, OH 43512 7724 Rte. 66 N. ph 419.784.9871 ohio@sukup.com	Jonesboro, AR 72403 204 Best Industrial Dr. ph 870.932.7547 arkansas@sukup.com	Watertown, SD 57201 2701 Piper Ave. ph 605.882.6697 southdakota@sukup.com
---	--	--	--	---	---